

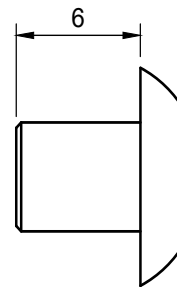
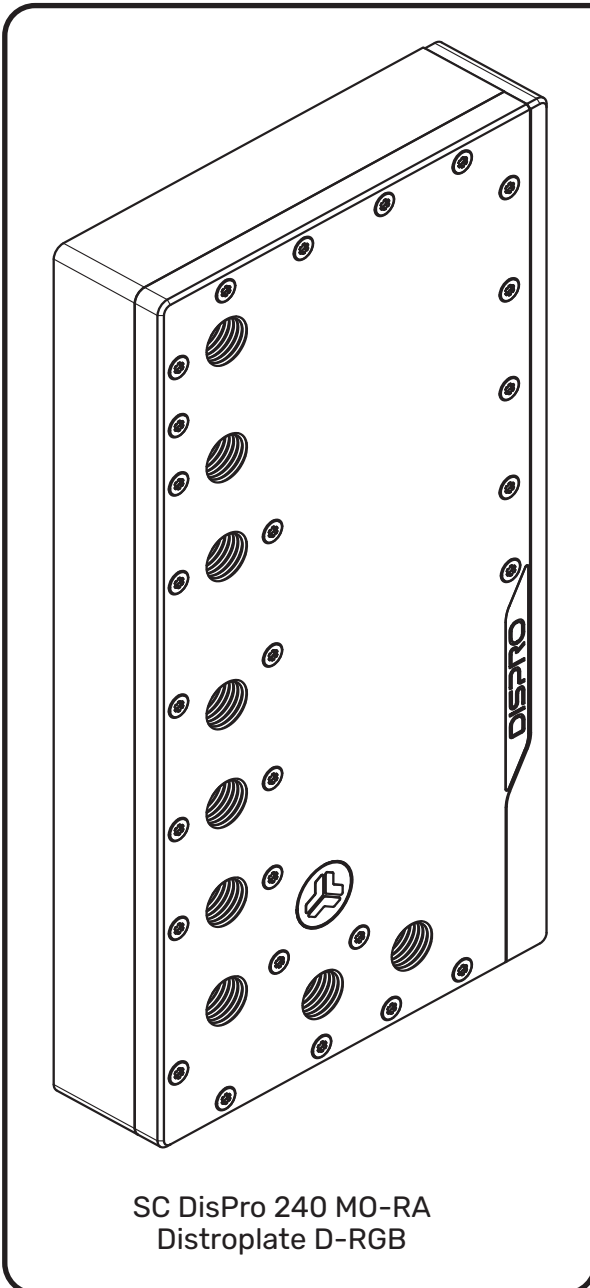

TABLE OF CONTENTS

- 1. PACKAGING CONTENT WARNING 3
- 2. DIMENSIONS (mm) 4
- 3. RECOMMENDED CONFIGURATION 5
- 4. INSTALLING THE DISTROBUTION PLATE 7
- 5. CONNECTING THE D-RGB CABLE 9
- 6. INSTALLING THE CONNECTIONS 9
- 7. CLEANING & CARE..... 9
- 8. SUPPORT AND SERVICE..... 9

1. PACKAGING CONTENT WARNING

This product is intended for advanced users. Improper installation may result in damage to your equipment. While every effort has been made to provide the most comprehensive information possible, Stealkey Customs assumes no liability, express or implied, for damage to your components resulting from the use of Stealkey Customs cooling products, whether due to errors or omissions on our part in the instructions below, or due to errors or defects in Stealkey Customs cooling products. Do not disassemble the distro plate. Doing so will void the warranty. Turn off your system and discharge your body's static charge before proceeding with the installation. If you do not feel comfortable performing the installation procedure, contact a qualified computer technician.

BOX CONTENTS

M4 x 6 mm for mounting the radiator directly to the case

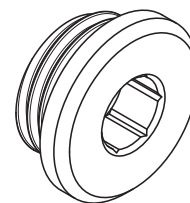

5 x G1/4 Plugs



2. DIMENSIONS (mm)

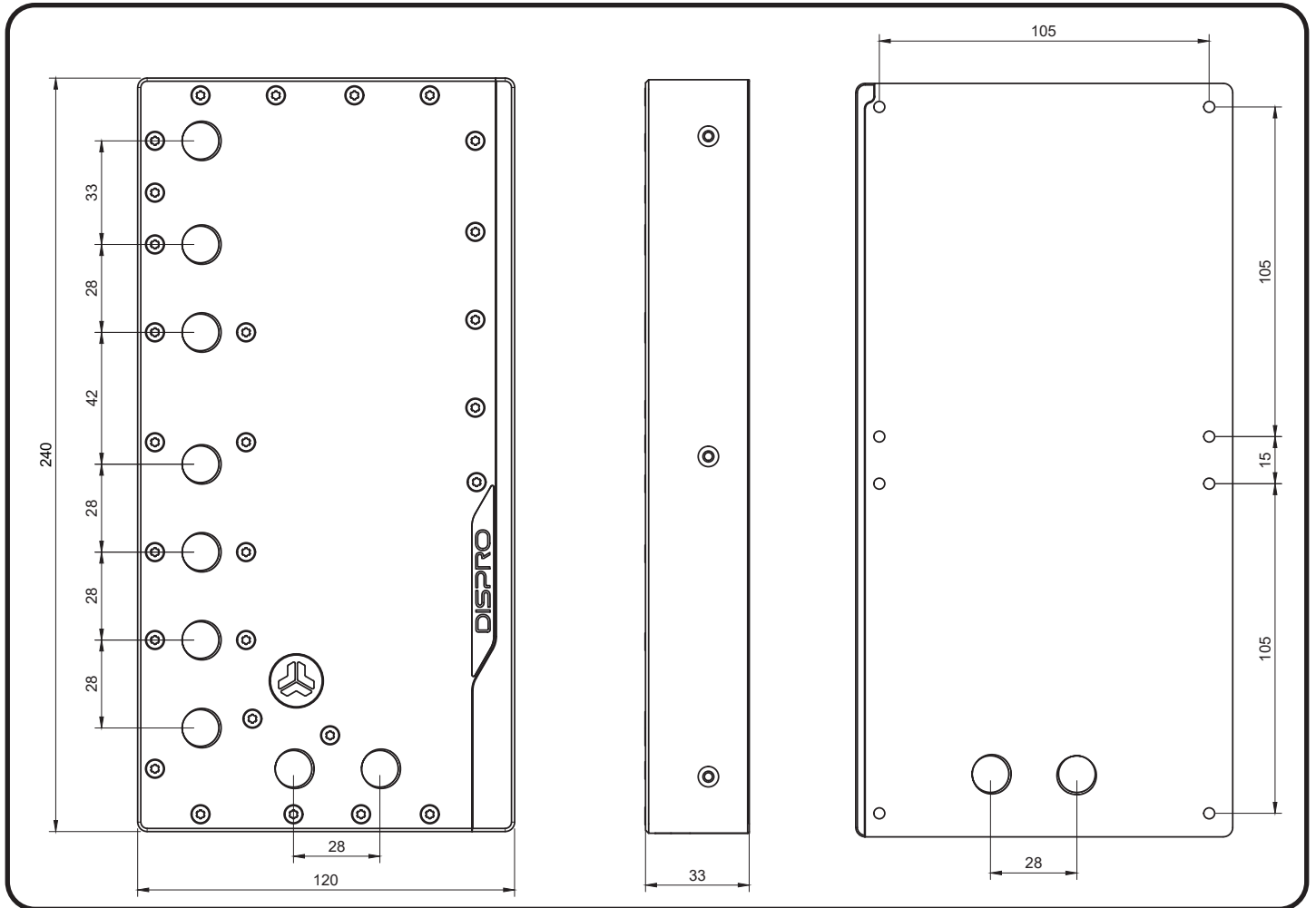



3. RECOMMENDED CONFIGURATION

FRONT VIEW

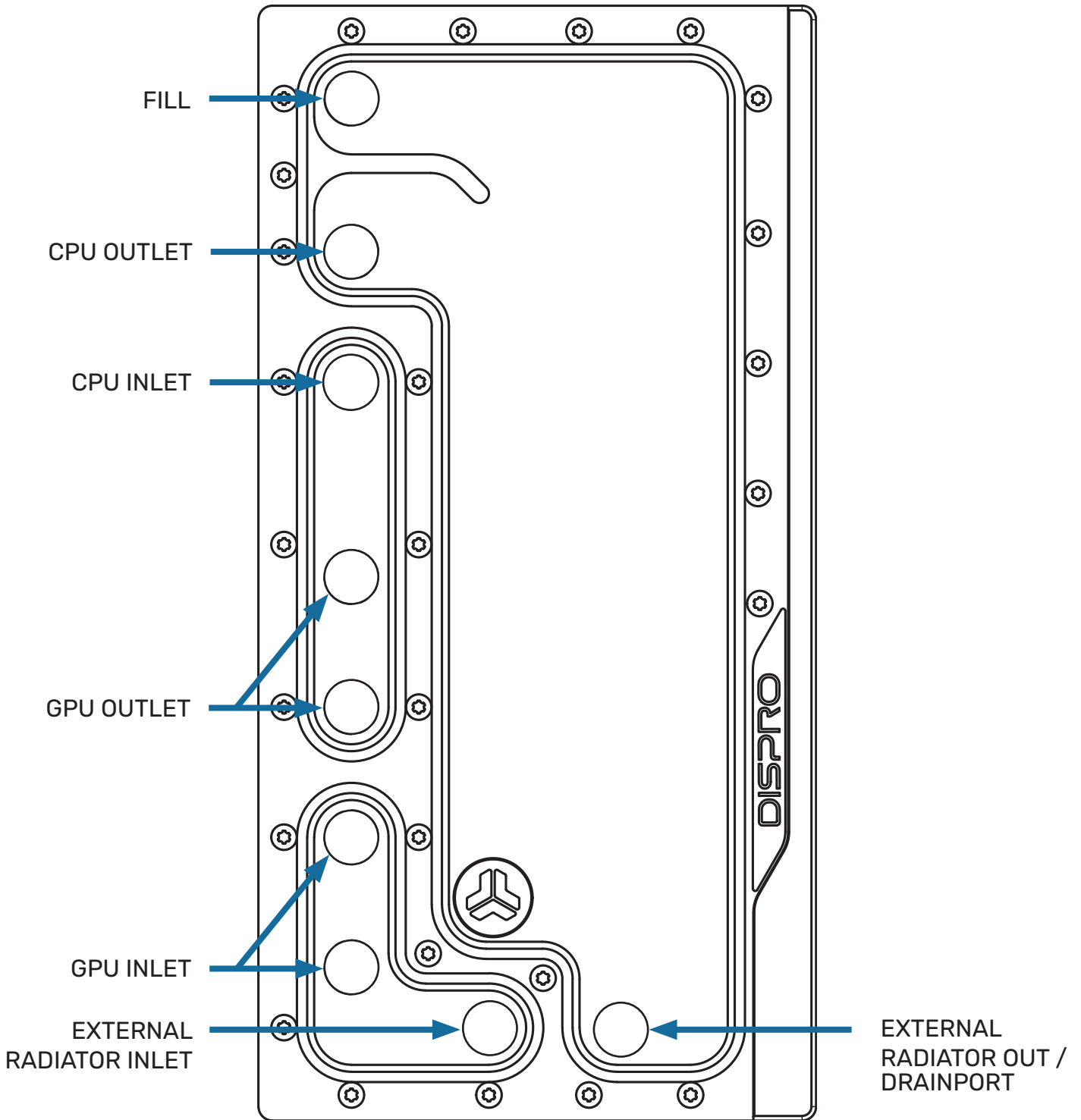

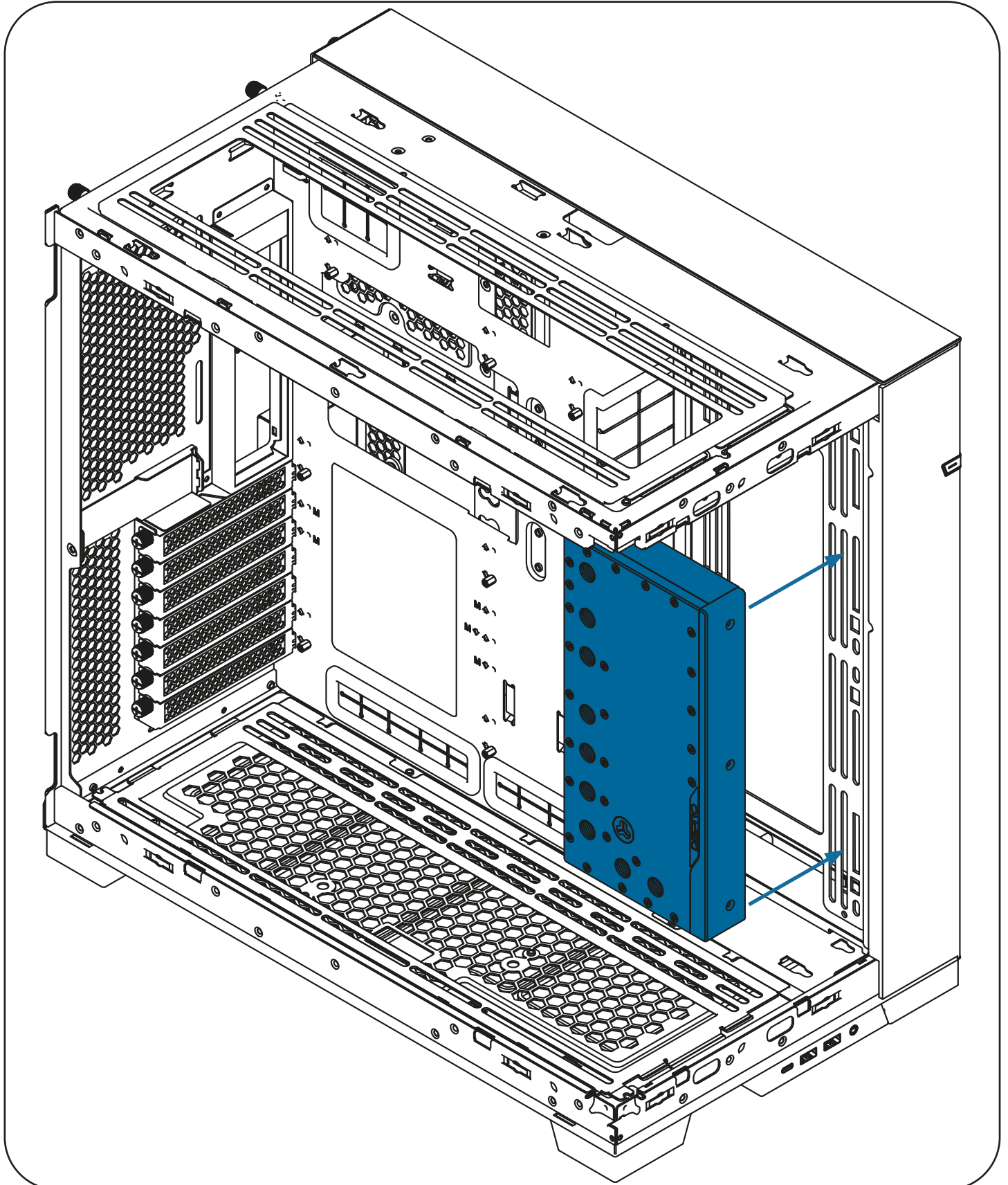

4. INSTALLING THE DISTROBUTION PLATE

Carefully place the distribution plate into the case and align the mounting holes. Be careful not to scratch the acrylic!

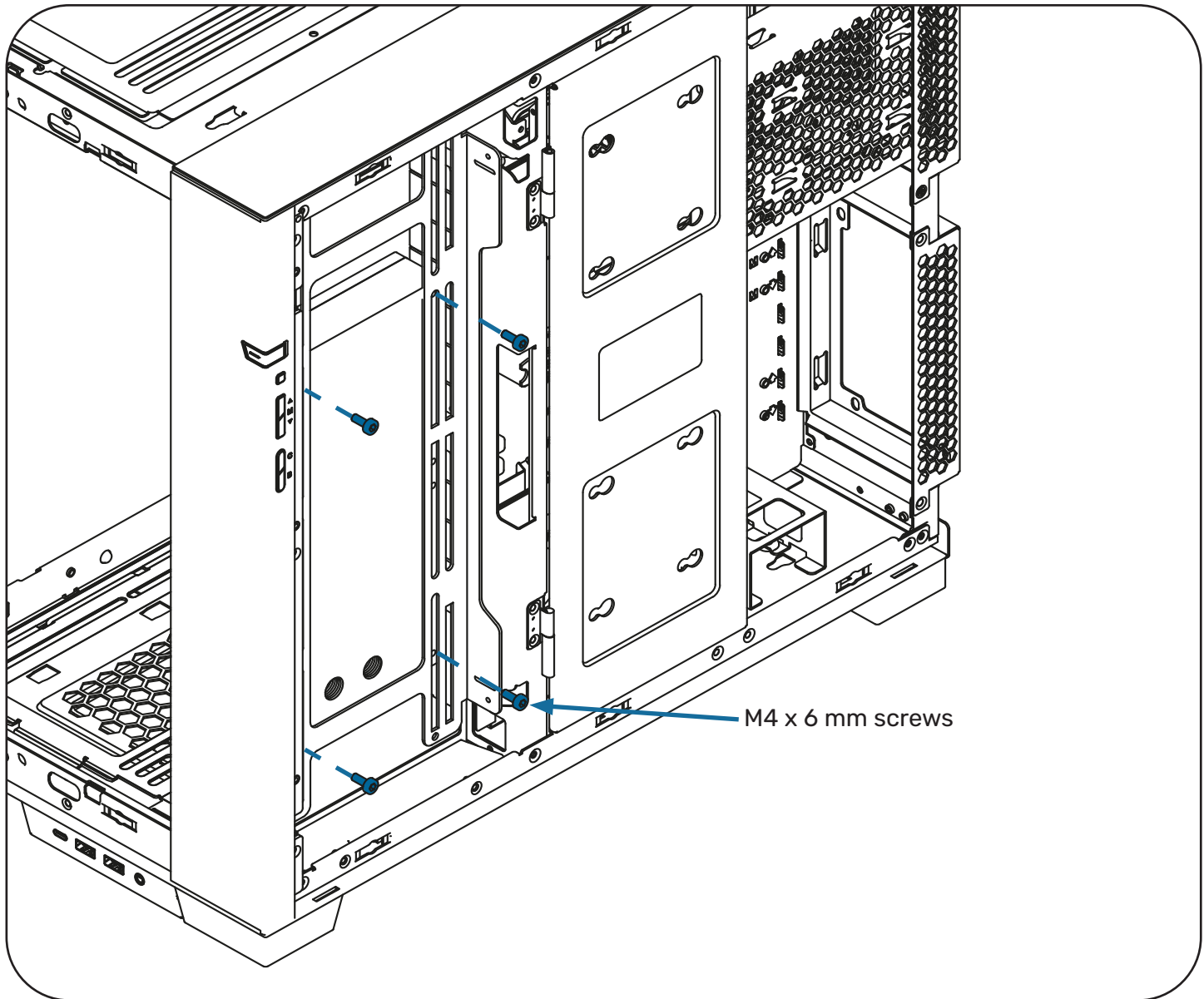

Using the included M4 x 6 mm screws you can mount the ResPro directly to your chassis or any other standard fan mounting location.



 Do not overtighten the screws to avoid cracks in the acrylic glass.

For this step, you will need:

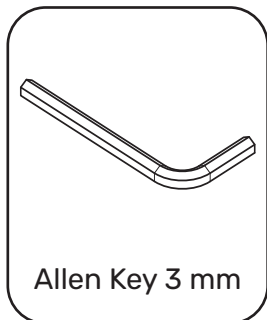
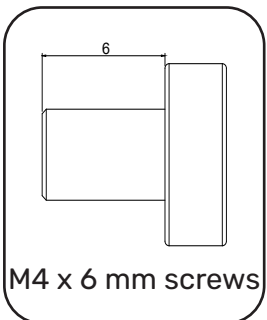

5. CONNECTING THE D-RGB CABLE

Connect the D-RGB cable to a compatible motherboard (3-Pin ARGB Connector).

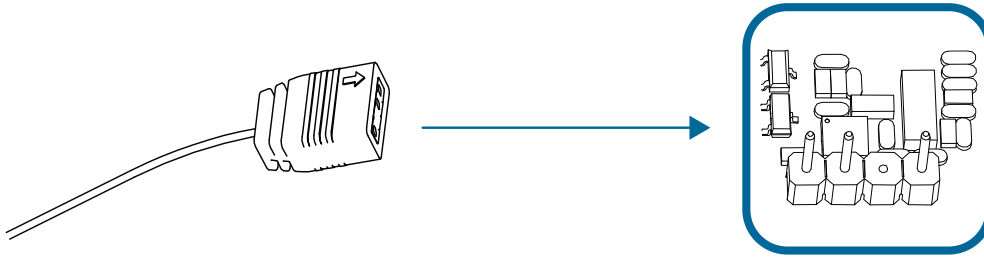

6. INSTALLING THE CONNECTIONS

Mount the connections with G1/4 thread and close the remaining connections with stop fittings. Always perform a leak test before applying power to the system components (max. 0,5 bar). Carefully loosen the shut-off valve of the filling connection to allow trapped air to escape.

7. CLEANING & CARE

Clean the distro plate only with microfiber cloths to avoid scratches in the material. Do not use cleaners containing alcohol to avoid stress cracks in the material. Before installing the distro plate, it is recommended to rinse the distro plate to remove any last residues. Acrylic paints can leave residues.

8. SUPPORT AND SERVICE

Contact

Stealkey Customs

Mail: support@stealkeycustoms.de

Instagram: <https://www.instagram.com/stealkeycustoms>

Website: <https://www.stealkeycustoms.de>

FAQ: <https://www.stealkeycustoms.de/pages/faq>

